

S89E,F Direct Spark Ignition Control Module

PRODUCT DATA

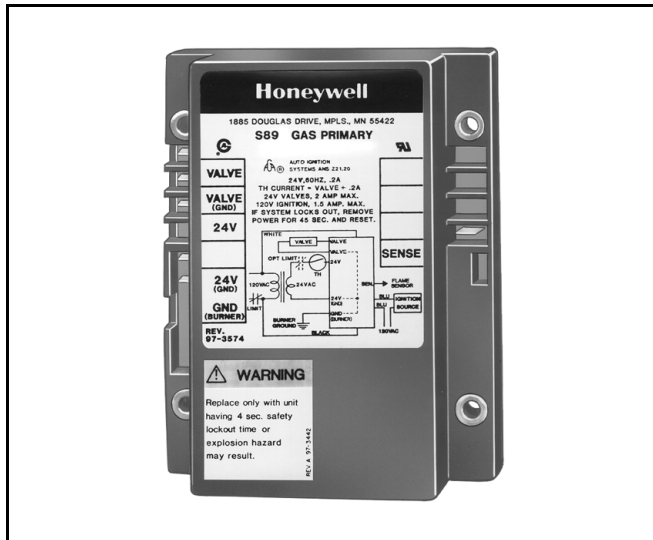

APPLICATION

The Honeywell S89E,F Direct Spark Ignition Control Modules control the ignition sequence and gas control operation in direct spark systems used primarily on gas-fired atmospheric and power burners in residential furnaces and heating appliances.

FEATURES

- Requires separate 120 Vac spark generator.
- S89E has 10-second maximum delay for safe start check before ignition.
- S89F has 38-second maximum delay for safe start check plus valve on delay before ignition.
- Available with 4 or 11 second (nominal) lockout timing.
- 100 percent shutoff for use with all heating gases.
- Ambient temperature rating is -40°F to +175°F (-40°C to +80°C).
- Separate electrodes for spark ignition and flame sensing.
- Uses Honeywell or any other 2A or less dual valve combination gas control designed for Direct Spark Ignition (DSI) applications.
- Locks out system after trial for ignition if main burner fails to ignite.
- Flame rectification principle used to monitor flame; false flame signals resulting from short to ground results in safety shutdown.
- After safety shutdown, S89E and F can be reset from the thermostat.

Contents

Application	1
Features	1
Specifications	2
Ordering Information	2
Installation	3
Wiring	4
Start-Up and Checkout	4
Operation	6
Troubleshooting	7



SPECIFICATIONS

IMPORTANT

The specifications given in this publication do not include normal manufacturing tolerances. Therefore, this unit may not match the listed specifications exactly. Also, this product is tested and calibrated under closely controlled conditions, and some minor differences in performance can be expected if those conditions are changed.

Models:

S89 Direct Spark Ignition Control Modules. Provide electronic control of direct spark ignition system on gas-fired atmospheric and power burners.

S89E: 10-second maximum delay for safe start check.

S89F: 38-second maximum delay for safe start check plus valve on delay.

Complete DSI system also includes:

120 Vac Spark Generator with 1.5A or less current draw.

Q347 Spark Igniter or equivalent.

Q354 Flame Sensor or equivalent.

VR845, VR854, VR8450, or VR8305 Combination Gas

Controls or any dual valve rated 2A or less and designed for DSI applications.

24 to 30 Vac Thermostat.

High Temperature Limit Controller.

24V Transformer. See Table 1 for VA rating.

Electrical Ratings:

Power supply: Requires two power supply connections—24 and 120 Vac, 50/60 Hz.

Current at 24V input: 2.2A maximum.

Valve Contacts: 2.0A maximum run, 20A maximum inrush at 24 Vac.

Spark Generator Relay Contacts: 1.5A at 120 Vac, 50/60 Hz.

Transformer Rating: See Table 1.

Thermostat Heat Anticipator Setting: 0.2A plus gas control current.

Delay Timing:

S89E: Safe Start Check—10 seconds maximum.

S89F: Safe Start Check plus Valve On Delay—38 seconds maximum.

Table 1. Transformer Rating.

S89 Current (in Amperes)	Gas Control Current (In Amperes)	Transformer VA Rating Required	Transformer Model No.
0.2	0 to 0.6	20	AT20A or AT120A
0.2	0.6 to 1.0	30	AT72D or AT140A
0.2	1.0 to 1.4	40	AT72D or AT140A
0.2	1.4 to 2.0	50	AT87A or AT150A

Safety Lockout Timing: 4 or 11 seconds nominal. Ignition is on during approximately the first 80 percent of lockout timing and off during the last 20 percent for flame proving. Specify lockout timing when ordering.

Flame Failure Response Time: 2 seconds maximum with 2.5 μ A flame current.

Flame Current Signal: 0.8 μ A minimum.

Ambient Temperature Range: -40°F to +175°F (-40°C to +80°C).

Wiring Connections:

24 Vac—3/16 in. quick-connects.

120 Vac—12 in. (305 mm) color-coded leadwires.

Sensing Lead: Up to 36 in. (0.9m). Insulation must be rated for 100 megohm resistance between wire and ground.

Mounting: Mounts in any position.

Dimensions: See Fig. 1.

ORDERING INFORMATION

When purchasing replacement and modernization products from your TRADELINE® wholesaler or distributor, refer to the TRADELINE® Catalog or price sheets for complete ordering number.

If you have additional questions, need further information, or would like to comment on our products or services, please write or phone:

1. Your local Honeywell Automation and Control Products Sales Office (check white pages of your phone directory).
2. Honeywell Customer Care
1885 Douglas Drive North
Minneapolis, Minnesota 55422-4386

In Canada—Honeywell Limited/Honeywell Limitée, 35 Dynamic Drive, Scarborough, Ontario M1V 4Z9.

International Sales and Service Offices in all principal cities of the world. Manufacturing in Australia, Canada, Finland, France, Germany, Japan, Mexico, Netherlands, Spain, Taiwan, United Kingdom, U.S.A.

Approvals:

Underwriters Laboratories Inc. Component Recognized: File No. MP268, Guide No. MCCZ2.

CSA International Certified: 158158-1047805.

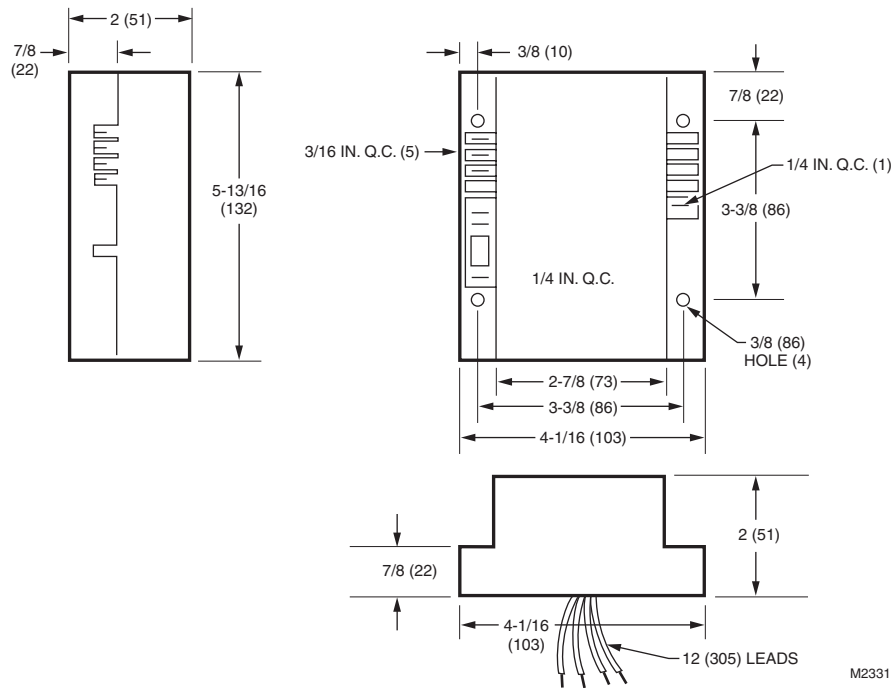

Fig. 1. S89 dimensions in in. (mm).

INSTALLATION

When Installing This Product...

1. Read these instructions carefully. Failure to follow them could damage the product or cause a hazardous condition.
2. Check the ratings given in the instructions and on the product to make sure the product is suitable for your application.
3. Installer must be a trained, experienced service technician.
4. After installation is complete, check out product operation as provided in these instructions.

⚠ WARNING

Fire or Explosion Hazard.

Can cause severe injury, death or property damage.

1. Disconnect power supply before wiring to avoid electrical shock, explosion, or equipment damage.
2. If a new gas control is being installed, turn off gas supply before starting installation. Conduct Gas Leak Test after gas control is installed.
3. In an LP gas installation, remember that LP gas is heavier than air and will not vent upward naturally. Do not operate electric switches, lights, or appliances until you are sure that work area is free of gas.
4. Never install an S89 where water can flood, drip, or condense on the device. It can malfunction if it gets wet.
5. Never try to use a device that has been damp or wet—replace it.
6. If the control might be exposed to water or moisture, install it in a suitable waterproof enclosure.
7. Any replacement S89 must have the same or shorter lockout time *and* the same or longer delay timing as the original control.

Replacement Application Requirements

If this is a replacement application, follow the appliance manufacturer instructions, if available. The manufacturer usually provides wiring diagrams, start-up and checkout

instructions, and service procedures for their appliance. If the manufacturer instructions are not available, use the general guidelines that follow.

Mount the S89

Select a convenient location on the burner or furnace chassis or cabinet, protected from moisture due to splashing, dripping, or condensation. Allow room to easily reach the S89 terminals for wiring and servicing. Do not exceed the ratings given in the Specifications section.

The S89 may be mounted in any position. See Fig. 1 for mounting dimensions. Mount with 1 in. (25 mm) long, no. 6-32 machine screws or no. 8 sheet metal screws. Fasten securely.

Mount Auxiliary Controls

Mount the spark generator, igniter, flame sensor, thermostat, transformer, gas control, and any other auxiliary controls according to the control manufacturer instructions.

WIRING



CAUTION

Equipment Damage Hazard.

Can cause equipment malfunction or damage.

1. The sensor leadwire must be no more than 3 ft (0.9m) long. Do not allow the wire to touch grounded metal surfaces.
2. A common ground is required for the S89, the spark igniter and the main burner. The 24V (GND) terminal internally grounds one side of the transformer. Auxiliary controls or limits must be in the ungrounded leg.



WARNING

Electrical Shock Hazard.

Can cause severe injury, death or property damage.

Disconnect the power supply before beginning wiring. More than one disconnect may be required.

Use wiring diagrams and instructions provided by the appliance manufacturer, if available. Otherwise, follow the general procedures and diagrams outlined below.

All wiring must comply with all applicable electrical codes and ordinances.

1. Make sure the transformer has adequate power (VA) rating. See Table 1 in Specifications section.
2. If you are replacing an S89 that was used with an external valve on delay timer, you must disconnect the external timer and use an S89F to provide the delay function. External timers cannot be used with either S89E or S89F controllers because the safety circuit in

the controls may repeatedly set the timer to zero, preventing burner start. Always disconnect the external timer when using an S89E or F. To disconnect the timer:

- a. Turn off power.
 - b. Cut the two leadwires at the external timer.
 - c. Strip the ends of the wires 1/2 in. (13 mm) and connect with a solderless connector.
 - d. Restore power.
3. Wire system components and S89 as shown in Fig. 2 and 3. Refer to appliance manufacturer instructions for connections to other auxiliary controls.
 4. Make sure the L1 (Hot) and L2 (Ground) leads are connected to the right leads. If they are reversed, the S89 will not detect the flame and will go into safety lockout.
 5. Connect spark igniter, flame sensor, main burner, and S89 to a common ground. Use thermoplastic insulated wire with a minimum rating of 221°F (105°C) for the ground wire. Connect the ground wire as follows:
 - a. Connect one end of the ground wire to the quick-connect GND (burner) terminal on the S89, using a 1/4 in. (6 mm) quick-connect (AMP 41772 or equivalent).
 - b. Strip the other end of the wire and fasten it under the igniter bracket mounting screw.
 - c. If necessary, install a shield to protect the wire from radiant heat generated by the burner.
 - d. The burner serves as the common ground. If metal-to-metal contact between the burner and the appliance cabinet is poor, run a lead from the burner to the cabinet. The cabinet must be earth-grounded.

START-UP AND CHECKOUT

If this is a replacement application, refer to the specific instructions provided by the heating appliance manufacturer (if available). Also, since the auxiliary controls used on any system may differ, refer to the control manufacturer instructions for start-up and checkout procedures for other system components.

Perform Gas Leak Test



WARNING

Fire or Explosion Hazard.

Can cause severe injury, death or property damage.

1. Never use a flame to check for gas leaks, only a soap and water solution.
2. Test for gas leaks whenever work is done on a gas system.
3. Soap and water must not touch the S89.

With the main burner in operation, paint the pipe joints and gas control gasket edges with a rich soap and water solution. Bubbles indicate a gas leak. To stop the leak, tighten joints and screws, or replace the gas control. *Never* use a flame to check for gas leaks.

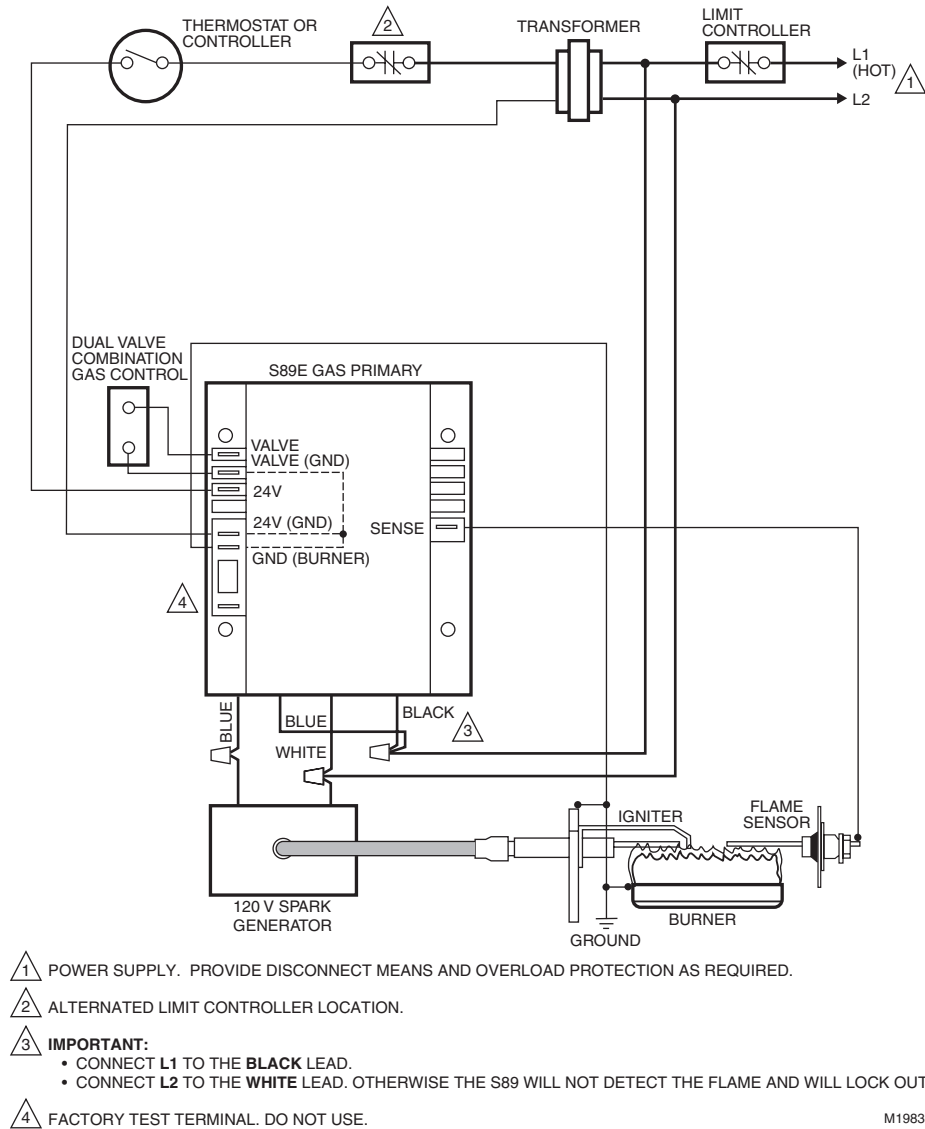

Fig. 2. S89E typical hookup in direct spark control system. See Fig. 8 for control system ladder diagram.

Check Out S89

NOTE: If operation is not as described below, refer to Troubleshooting section.

1. Set thermostat to call for heat.
2. Turn on power and gas supply.
3. Igniter starts to spark and gas control opens after safe start check (S89E: 10 seconds maximum) or safe start check plus valve on delay (S89F: 30 seconds minimum).
4. Main burner lights while igniter is on.

NOTE: If the gas control has been replaced or serviced, lightoff may be unsatisfactory until air has been purged from the gas line or the gas input and combustion air have been adjusted (see appliance manufacturer instructions).

5. Turn off gas supply.
6. Gas control closes.
7. The module begins the safe start check (S89E: 10 seconds maximum) or safe start check plus valve on delay (30 seconds minimum) after which the igniter starts and gas control opens.
8. Time system until gas control closes. S89 is now in safety lockout. The lockout time should be within the specifications in Table 2.
9. Open gas supply. System remains off and no gas flows to the main burner.

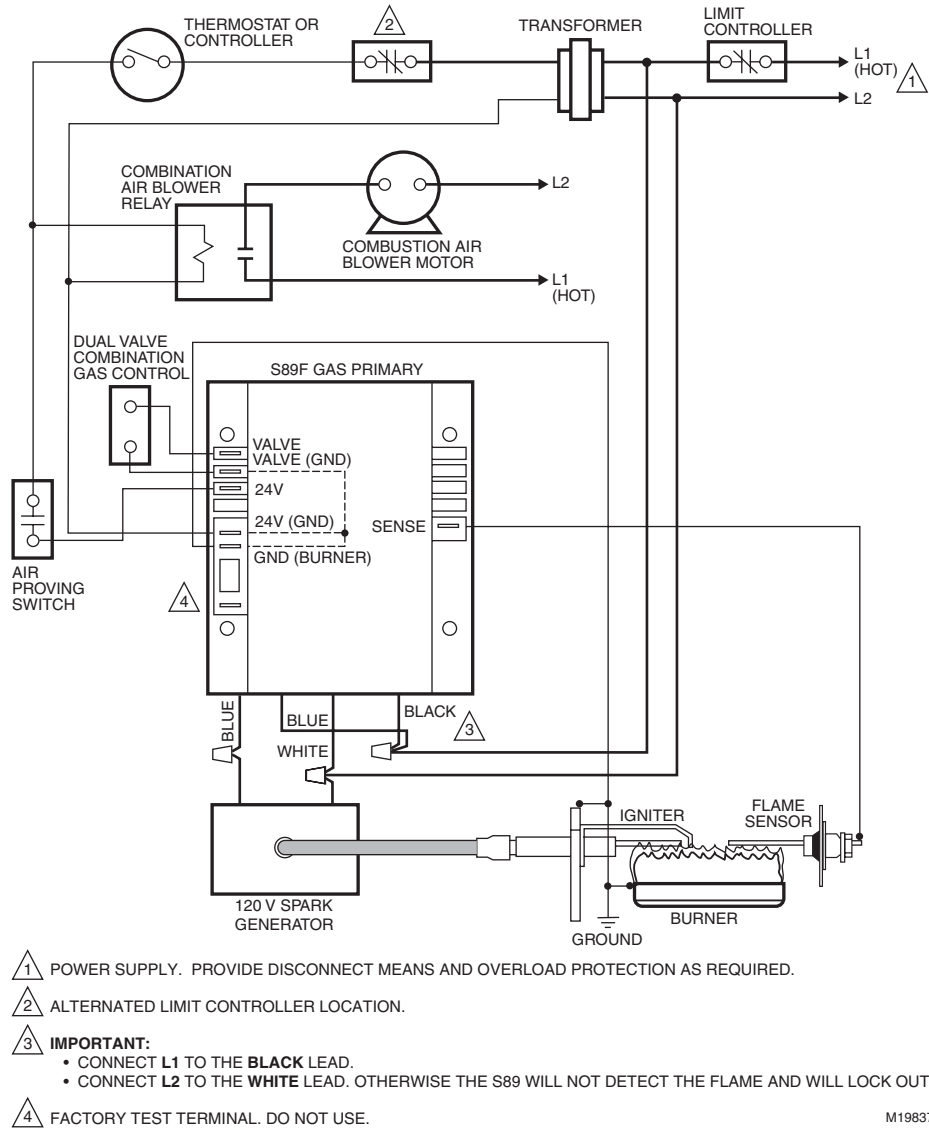

Fig. 3. S89F typical hookup in direct spark control system. See Fig. 9 for control system ladder diagram.

10. Turn off gas supply.
11. Gas control closes.
12. The module begins the safe start check (S89E: 10 seconds maximum) or safe start check plus valve on delay (38 seconds maximum) after which the igniter starts and gas control opens.
13. Time system until gas control closes. S89 is now in safety lockout. The lockout time should be within the specifications in Table 2.
14. Open gas supply. System remains off and no gas flows to the main burner.

Table 2. S89 Lockout Times.

Lockout Time Shown on S89 Module	Safety Lockout Time	
	Minimum	Maximum
4 seconds	3.0 seconds	5.5 seconds
11 seconds	8.0 seconds	15.0 seconds

Resetting S89 After Safety Lockout

Once the S89 locks out, it must be reset before the system will operate. To reset, set the thermostat below room temperature, wait at least 45 seconds, then turn the thermostat up to call for heat. The system should start normally. If adjusting the thermostat does not reset the S89, turn off power to the appliance for 45 seconds and then turn it on.

Final Checkout

With power and gas supply on, set thermostat to call for heat and observe operation through at least one complete cycle to make certain that all controls are operating safely.

OPERATION

The S89 is powered by a 24V transformer. It operates in response to a call for heat from the thermostat.

On every call for heat, the S89 performs a safe start check. If a flame or a flame simulating condition is present, the S89 locks out without starting the igniter and must be reset.

Following the safe start check and, on the S89F, a valve on delay period, the S89 spark generator contacts close to energize the spark generator and the igniter. At the same time the gas control, powered through the gas valve relay contacts in the S89, opens so gas can flow to the burner. The igniter is on during approximately the first 80 percent of the ignition, or lockout timing, period. During the balance of the lockout timing period, the ignition is off and the flame sensor attempts to prove the flame. The flame is proved when current from the flame sensor through the burner flame to ground reaches 0.8 μ A dc.

If flame is proved, the gas control remains open and the burner on until the call for heat ends.

If flame is not proved, the gas control closes and the system is locked out until the S89 is reset.

If flame is lost after being proved, the S89 will close the gas control, perform a safe start check, and, on the S89F, valve on delay, then return ignition as described above.

The S89 is reset by turning the thermostat below room temperature or removing power to the system for 45 seconds.

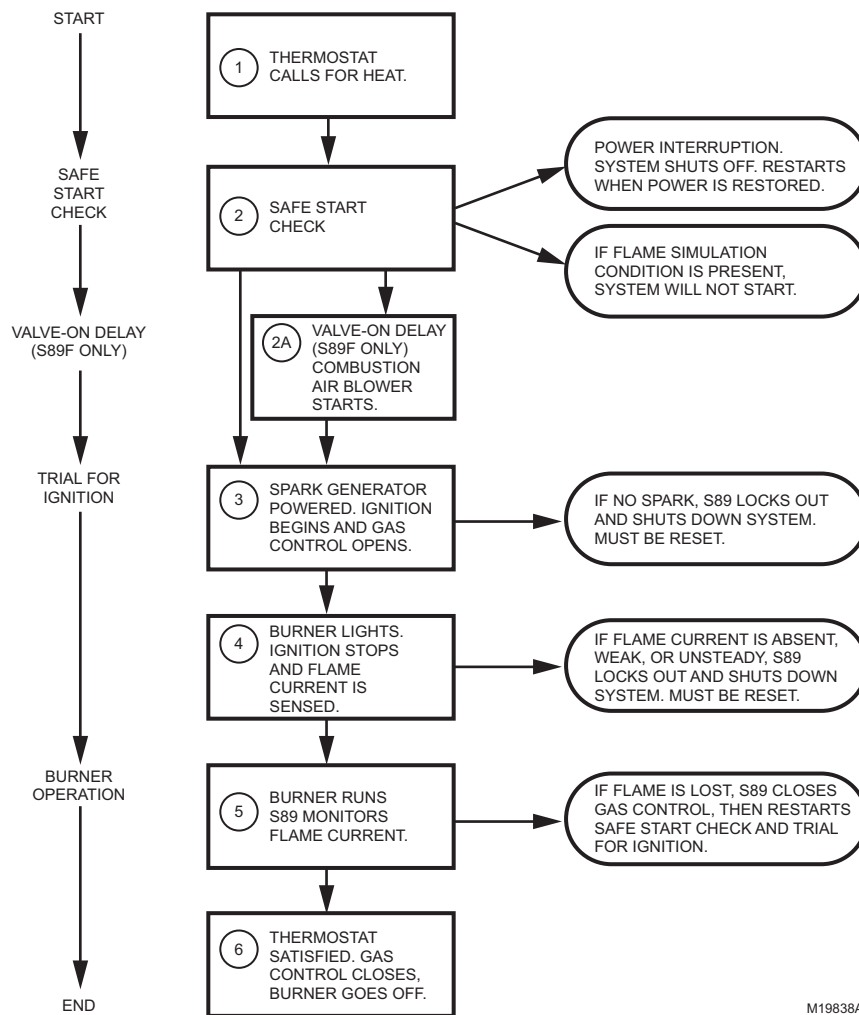

Fig. 4. Normal sequence of operation.

TROUBLESHOOTING



WARNING

Fire or Explosion Hazard.
Can cause severe injury, death, or property damage.

Any replacement S89 must have the same or shorter lockout timing *and* the same or longer delay timing as the original control.

IMPORTANT

1. The following service procedures are provided as a general guide. Follow appliance manufacturer service instructions, if available.
2. All meter readings must be taken within the trial for ignition period. Once the ignition period ends, the system must be reset by setting the thermostat down for at least 45 seconds before continuing.
3. If any component does not function properly, make sure it is correctly installed and wired before replacing it.
4. The ignition module cannot be repaired. If it malfunctions, it must be replaced.
5. Only trained, experienced service technicians should service direct spark ignition systems.

Before beginning troubleshooting, review the normal operating sequence of the S89. See the Operation section. Then follow the steps in Fig. 5 to identify the source of the problem. Some steps are explained in greater detail below.

Besides standard hand tools, you will need the following to complete the troubleshooting:

1. Honeywell W136 Test Meter or equivalent.
2. Test lead: a length of ignition cable or other heavily insulated wire with both ends stripped 1/2 in. (13 mm).

Check Ignition System Grounding

Nuisance shutdowns are often caused by a poor or erratic ground.

A common ground is required for the module, igniter, flame sensor and main burner.

1. Check for good metal-to-metal contact between the igniter bracket and the main burner.
2. Check the ground lead from the GND (Burner) terminal on the module to the igniter bracket. Make sure connections are clean and tight. If the wire is damaged or deteriorated, replace it with no. 14 to 18 gauge, moisture-resistant, thermoplastic insulated wire with a 221°F (105°C) minimum rating. Use a shield if necessary to protect the ground wire from radiant heat.

Check Spark Ignition Circuit

The S89 spark generator relay switches 120 Vac to the remote-mounted spark generator, which, in turn, powers the spark igniter at the burner. Check as follows:

1. Shut off gas supply to the gas control.
2. Disconnect the ignition cable at the spark generator stud terminal.

3. Set the thermostat to call for heat.
4. Reset the S89 by removing power to the module for 45 seconds.

⚠ WARNING**Electrical Shock Hazard.**

Can cause severe injury, death, or property damage.

In the next step, *do not touch* either the stripped end of the test lead or the stud terminal.

5. Restore power. Before the S89 locks out, touch one end of the test lead firmly to the S89 GND terminal. Do not remove the existing ground lead.
6. Slowly move the other end of the test lead toward the stud terminal on the spark generator until sparking stops.
7. Slowly pull the wire away from the stud terminal and note the size of the gap when sparking stops.
8. Follow instructions in Table 3.

Table 3. Spark Ignition Troubleshooting.

If the Gap Was:	Then:
1/8 in. (3 mm) or more	Generator output voltage is okay.
Less than 1/8 in. (3 mm) or no spark	Check for 120 Vac at the spark generator terminals. If okay, replace the spark generator.

Check Flame Sensor and Igniter

1. Make sure burner flame is capable of providing a good rectification signal. See Fig. 7.
2. Make sure about 3/4 to 1 in. (19 to 25 mm) of the flame sensor is continuously immersed in the flame for best flame signal. See Fig. 7. Bend the bracket or flame sensor, or relocate the sensor as necessary. Do *not* relocate the igniter.
3. Make sure flame does not touch sensor or ignitor ceramic insulator and that insulators are below the flame. Excessive heat (over 1000°F [538°C]) will cause short to ground. Move sensor to cooler location or shield insulators if excessive heat is suspected. Do *not* relocate the igniter.
4. Check for cracked igniter or sensor ceramic insulator, which can cause short to ground, and replace unit if necessary.
5. Make sure electrical connections are clean and tight.
6. Replace damaged wire with moisture-resistant no. 18 wire rated for continuous duty up to 221°F (105°C).

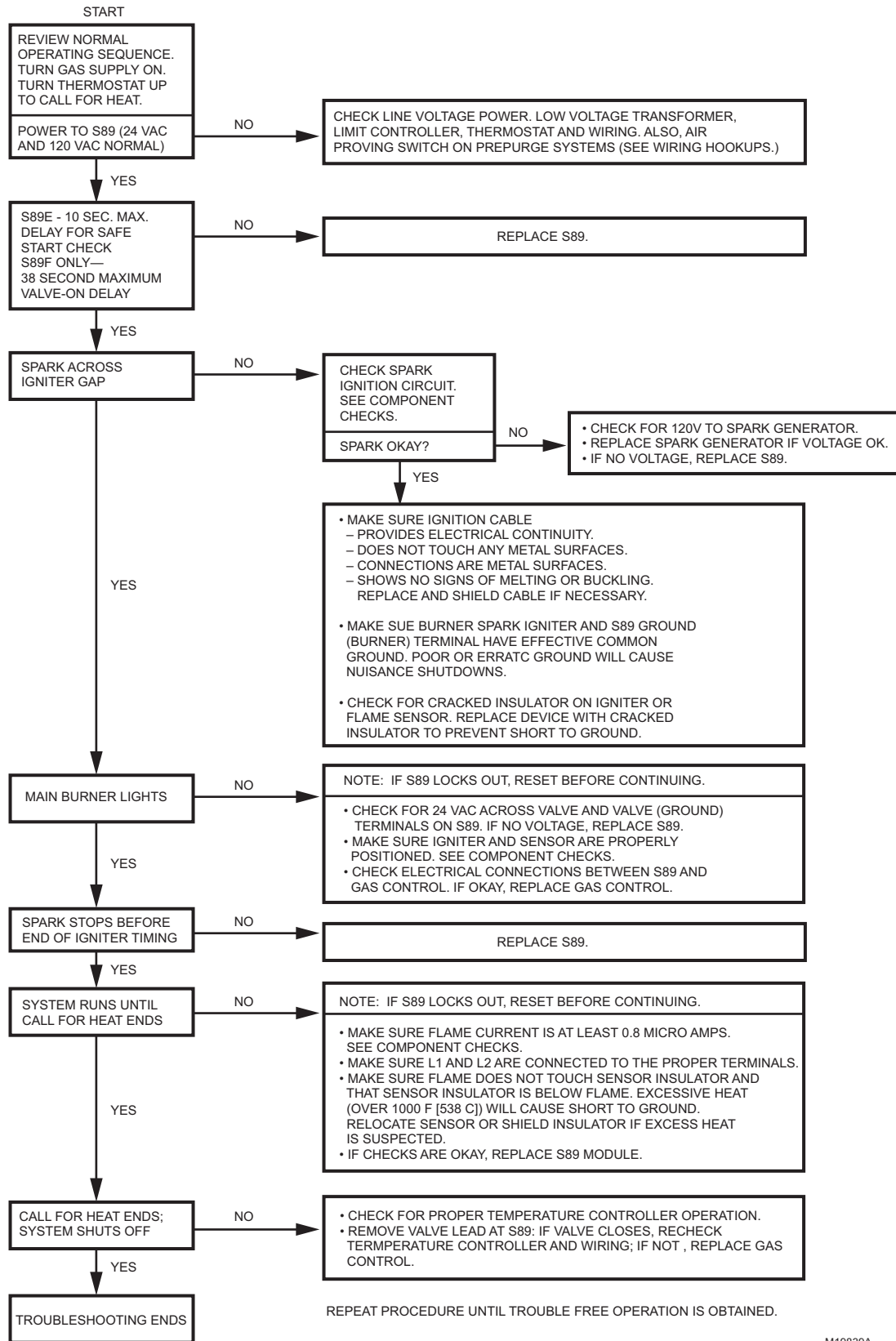

M19839A

Fig. 5. Troubleshooting S89E,F.

Measure Flame Current

The S89 provides ac power to the flame sensor which the flame rectifies to direct current. If the flame signal back to the S89 is less than 0.8 μA , the S89 will shut down the system.

To measure the flame current:

1. Connect a meter, set to the dc microammeter scale, in series with the flame sensor as shown in Fig. 6. Use the Honeywell W136 Test Meter or equivalent. Connect the meter as follows:
 - a. Disconnect the sensor lead at the S89.
 - b. Connect the red (positive) meter lead to the S89 sense terminal.
 - c. Connect the black (negative) meter lead to the free end of the sensor lead.
2. Restart the system and read the meter. The flame sensor current must be at least 0.8 μA and steady.

3. If the meter reads less than 0.8 μA or reading is unsteady, recheck points under Check Flame Sensor and Igniter, above.

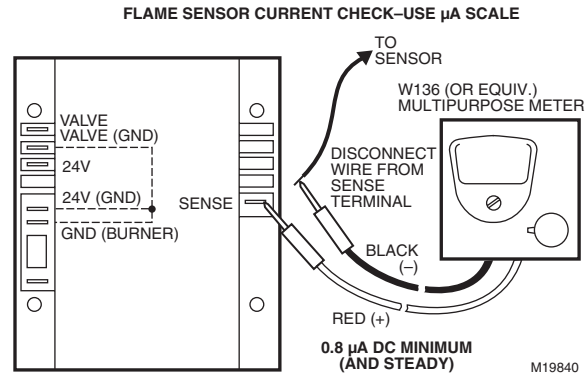

Fig. 6. S89 flame current measurement.

CHECK BURNER FLAME CONDITION

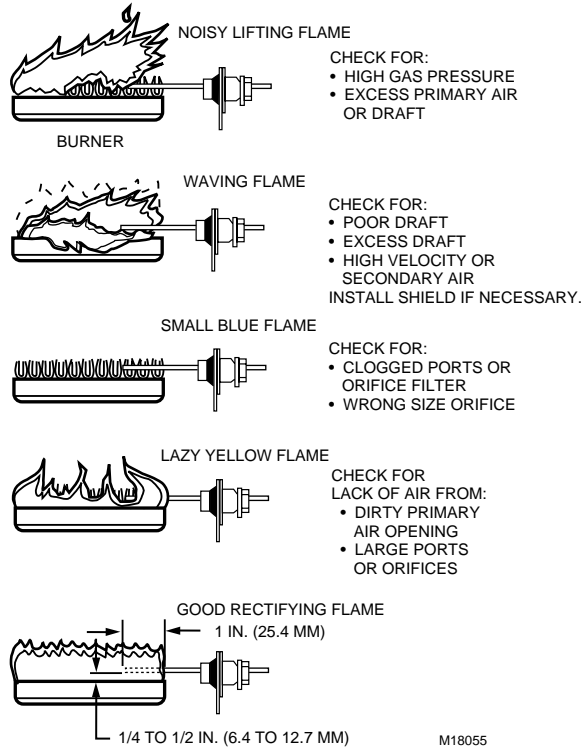

Fig. 7. Check burner flame condition.

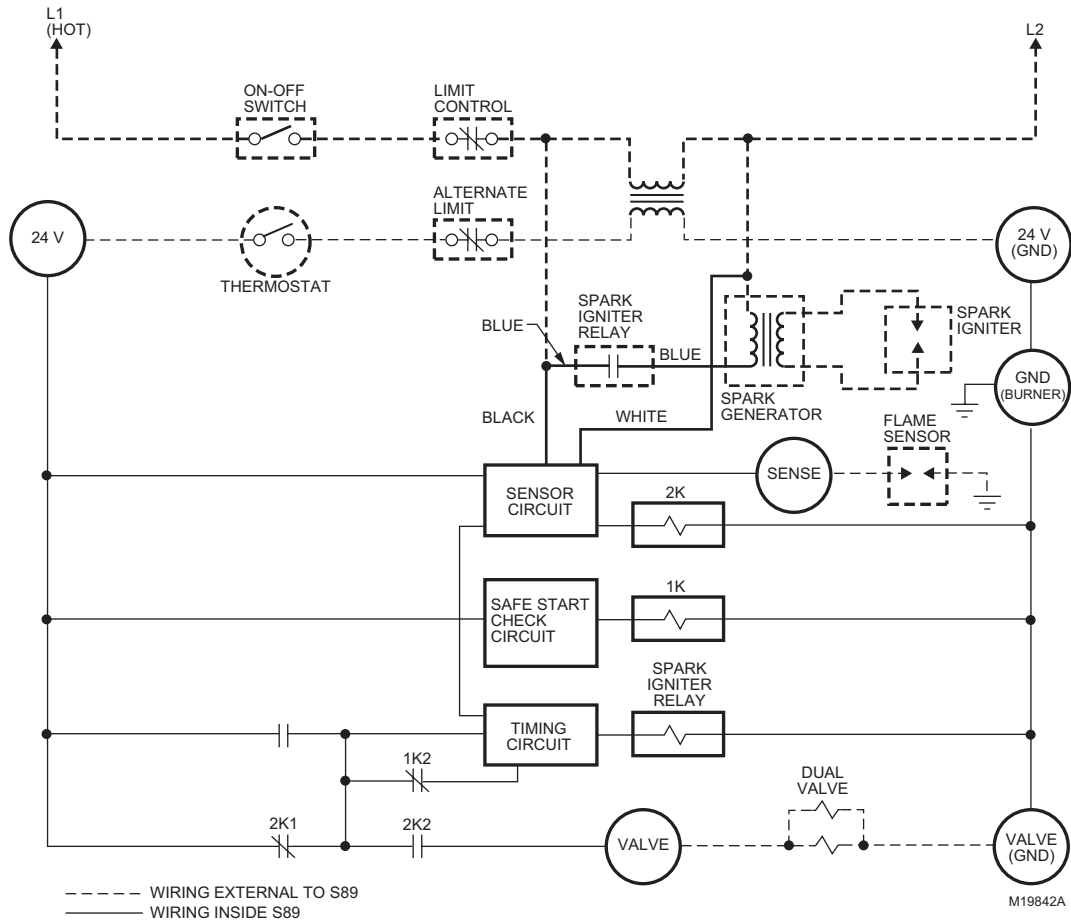

Fig. 8. S89E simplified control system schematic.

